

# WALL-MOUNTED FRONT LOADING WASHING MACHINE

---

# USER'S MANUAL

DY-BGX50W  
DY-BGX50HW



**Please read this manual carefully before use**

We reserves the right to interpret the user's manual.

Please keep this user's manual for future use.

In case of product technology or software upgrades, without notice.



# Contents

---

## Prepare

Special Feature .....	2
Safety Information .....	3
Control Panel (A).....	7
Control Panel (B).....	8
Prepare .....	9
Component .....	10
Clothes can be washed .....	11
Clothes can not be washed. ....	11
About Detergent Box info .....	12
Wash Procedure .....	13

## Use

Procedure Select and Setting .....	14
Function Select .....	18
Run and Finish .....	19
Daily Care and Maintenance .....	20

## Install -ation

Installation .....	22
While Error .....	25
Before you call the Service .....	26
The name and content of hazardous substances in the product .....	27
Specications .....	28



# Special Feature

## **DD Direct Drive Motor, Ultra-Quiet**

Using DD direct drive motor, it runs more smoothly and has lower noise.

## **Visible and Hidden Touch Control**

The hidden touch panel fully displays the sense of science and technology, and the washing instruction can be issued with the touch of finger, which is comfortable to operate and easy to use.

## **Automatically Add Detergent (optional function machine)**

The precise dosage of detergent not only saves operating time, but also optimizes the washing effect, avoiding the problem of detergent residue caused by excessive manual supply.

## **Hot Wash**

Hot wash at high temperature can completely eliminate bacteria and mites. So you can wear it comfortable.

## **Drum Self -Cleaning Wash**

Thoroughly clean the inner and outer tubs of the washing machine to avoid secondary pollution of the clothes.

## **Fast Wash**

Wash clothes immediately, bid farewell to waiting, save water and electricity, and enjoy a low-carbon life.

## **Smart Body**

Wall-mounted installation, smart and stylish body, saving space and more atmospheric and beautiful.

## **Double Spray, No Stains Remain**

Double spray, wash away residual stains on clothes, door glass and door seal, and eliminate secondary pollution.

## **Emergency Drainage**

In emergency situations such as power failure, drain the water in the drum in time to avoid odors caused by the clothes soaking for too long.



# Safety Information

This product is not suitable for use (including children) with defects in physical, sensory or mental abilities. Please use it safely under the guidance of a guardian.



Precautions to avoid situations that may cause death or serious personal injury.



Precautions to avoid situations that may cause minor personal injury or product damage.



Do not use the washing machine while the power cord or cable damaged or loose.



Please cut off the power while the washing machine not work, Smoke or emit an unusual smell.



Do not scratch, bend, stretch, or wind the power cable to make it damaged, deformed or knotted. Do not place heavy objects on the power cord.

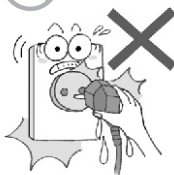

Do not unplug or plug in with wet hands.



Please make sure the voltage frequency and currency match the machine.



Do not disassemble or repair by yourself.



# Safety Information



Please connect the plug directly to an interface that can withstand at least 10A current.

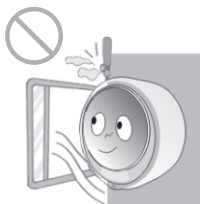

For safety, please ensure that the electrical appliance is grounded.



If the pins of the power cord are covered by dust or water, please wipe them with a dry cloth before use.

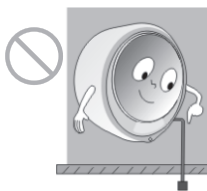

If a gas leak occurs, do not touch any buttons, unplug the power cord and open windows for ventilation.



Do not expose the washing machine to wind and rain.



Do not put gasoline, petroleum, benzene, thinner or alcohol into the washing machine or near the washing machine, and do not put substances containing the above materials into the washing machine or put it near the washing machine



Please unplug the power cord before cleaning or maintenance work.



When the washing machine is running, do not put your hands or metal objects under the washing machine



Do not install the washing machine near a fire source, and do not place candles or cigarettes on the washing machine.



Children are prohibited from operating the washing machine. Do not let children stand on the washing machine or put their heads into the washing machine tub at any time.



# Safety Information



Please install the washing machine close to the power outlet. If you do not use the washing machine for a long time, unplug the power cord.



Do not stand on the washing machine or place heavy objects on the washing machine.



Do not open the door forcibly while the door is locked.



Do not put pets and other animals into the washing machine barrel.



Please turn on the faucet to check for water leakage before use.



Do not place magnets near the cover or washing machine while the washing machine is running.



Please install the washing machine on a solid wall.



Do not use the wash bag.



# Safety Information



Do not use the washing machine when the washing machine is tilted or in an unbalanced state.



Do not wash sleeping bags or waterproof clothing such as leather, raincoats, car covers, etc.



Please use a soft damp cloth to remove the detergent or contaminants remaining on the washing machine.



Pay attention to closing the door to prevent clothing from jamming the door.



Please turn off the faucet after use.



If the water supply is suddenly cut off, please turn off the faucet in time.



Do not use the washing machine to wash non-clothing items, (shoes, potatoes, cabbage, kelp, etc.



When moving the washing machine, remove all liquid detergent from the machine.





# Control Panel (A)

USED FOR DY-BGX50W

<p>[Smart][Hot][Quick] [Acarid][Baby][Shirt] [Self-C][Spin][R+Spin] [Eco40-60][Intense] [Care]</p> <p>According to the needs, touch the corresponding button to select the appropriate laundry program, and the corresponding indicator light will be highlight after the program is selected.</p>	<ul style="list-style-type: none"> <li>🕒 1888: The remaining time of the program.</li> <li>🔒 Child lock function: touch the "temperature" button for 3 seconds, the "icon" is always on, and the child lock function is turned on.</li> <li>🧴 Detergent function: The icon of automatically adding detergent is light on and the function is turned on. optional function machine.</li> <li>🌐 Internet of Things optional function.</li> </ul>	<p>[Temperature] Touch this key to set different washing temperatures. [Water Level] Touch this key to set different water level heights. [Delay] Touch this key in standby mode to select the required appointment time (within 1:00-24:00). The appointment time is the end time, that is, the washing completion time.</p>	<p>[Power] Touch this button to turn on the power. If the washing machine needs to be turned off urgently during operation, press and hold this button for about 3 seconds to turn it off. After pressing this button to turn on the power, if the washing machine does not start within 3 minutes, washing ma will automat turn off the the chine ically power.</p>
--	--	---	--



<ul style="list-style-type: none"> <li>🧺 [Wash]</li> <li>🌊 [Rinse]</li> <li>🌀 [Spin]</li> <li>🧴</li> </ul> <p>The ashing icon represents the current running status.</p>	<p>[Night] Night wash is a program with less noise that is specially designed for the quiet time at night, so as not to affect the user's rest</p> <p>[Rinse+] Touch this key to choose the rinse times.</p> <p>[Detergent] Touch this key for auto add detergent. (It it ash before machine work, it need add detergent in the box.)</p>	<p>Add clothes midway Press the "Start/ Pause"key to check the water level, temperature, and motor, and automatically open the door when the door is opened. When the door lock can be opened, clothes can be added. Press the "Start/Pause" button again to continue washing.</p>	<p>[Start / Pause] Touch this key, the washing machine will start to run according to the pre-set program. Touch this button again after running, the washing machine will stop. (When the child lock is turned on, the child lock must be released before the suspension)</p>
--	---	--	--



# Control Panel (B)

USED FOR DY-BGX50HW

[Smart][Hot][Quick]  
[Acarid][Baby][Dry]  
[Self-C][Spin][R+Spin]  
[Eco40-60][Intense]  
[Care]

According to the needs, touch the corresponding button to select the appropriate laundry program, and the corresponding indicator light will be high after the program is selected.

⌚ 1888: The remaining time of the program.

🔒 Child lock function: touch the "temperature" button for 3 seconds, the "icon" is always on, and the child lock function is turned on.

🧴 Detergent function: The icon of automatically adding detergent is light on and the function is turned on. optional function machine.

📶 Internet of Things optional function.

[Temperature]

Touch this key to set different washing temperatures.

[Water Level]

Touch this key to set different water level heights. [Delay]

Touch this key in standby mode to select the required appointment time (within 1:00-24:00). The appointment time is the end time, that is, the washing completion time.

[Power]

Touch this button to turn on the power. If the washing machine needs to be turned off urgently during operation, press and hold this button for about 3 seconds to turn it off.

After pressing this button to turn on the power, if the washing machine does not start within 3 minutes, washing machine will automatically power off.



🧺 [Wash]

🧺 [Rinse]

🌀 [Spin]

🧺 [Dry] procedure. The washing icon represents the current running status.

[Dry]

Touch this key after selecting the washing program, you can automatically enter the drying program after the washing is completed.

[Rinse+]

Touch this key to choose the rinse times.

[Detergent]

Touch this key for auto add detergent.

(It is ash before machine work, it need add detergent in the box.)

Add clothes midway Press the "Start/Pause" key to check the water level, temperature, and motor, and automatically open the door when the door is opened. When the door lock can be opened, clothes can be added. Press the "Start/Pause" button again to continue washing.

[Start / Pause]

Touch this key, the washing machine will start to run according to the pre-set program. Touch this button again after running, the washing machine will stop. (When the child lock is turned on, the child lock must be released before the suspension)



# Prepare

## before prepare

Check the washing label on the laundry to see if it is suitable for machine washing. Otherwise, if the wrong washing method is selected, it may cause damage or deformation of the clothes. The Kangbei washing machine is not responsible for this.

Clothes with lint or hair attached should be washed after removing lint or hair to prevent the lint or hair from attaching to the clothes after washing. For clothes with a lot of mud and dust, please clean the mud or large dirt before washing. If it is a particularly dirty part, please pre-apply detergent in advance, so that it is easier to remove the dirt on the part.

In order to improve the washing effect, please wash the easily faded clothes separately from other clothes, and wash the dark and light-colored clothes separately. When washing the clothes, please evenly distribute the clothes in the bucket.

Please wash clothes that are prone to pilling, long piles, and clothes with larger buttons before turning the inner layer of the inner layer outwards to avoid the buttons colliding with the inner wall of the barrel and making noise during the washing process.

Please clean up coins, hairpins, clips, curtains and other foreign objects in your laundry pocket to avoid blockage of the drainage pipe and product failure. Please repair damaged clothing before washing. Please tie the long strap, fasten the buttons, and zip the zipper. Do not put clothes contaminated by chemicals directly into the washing machine.

Dw much, please unroll the clothes before putting them in.

## washing machine prepare

Connect the elbow of the drain pipe to the drain pipe of the washing machine, be sure to insert it to the end, and x it with a pipe clamp.

Do not step on, pull or bend the drain pipe.

Make sure that the drain pipe is tightly connected.

A slight water leak may occur during the installation process or the initial cycle. This is not caused by malfunction or mechanical failure, but the residue left by the product during the factory performance test.

Connect the water inlet hose and turn on the faucet .

Check whether there is water leakage around the hose and at the water inlet hose connection.

The water inlet hose is connected to the water inlet of the washing machine. It must be connected to the end and locked.

## plug in the power plug

Check the grounding procedures to prevent electric shock.

Check whether the socket can withstand the maximum power load of the washing machine. Check whether the power supply voltage meets the required value.

## ⚠ WARNING

This washing machine is limited to cold water washing, please do not connect the water inlet hose to the hot water faucet.

When using it for the first time, please install the drain pipe and water inlet pipe of the washing machine in accordance with "Installation" (P19).

If the machine is used in an environment with a temperature of zero degrees or below, the water inlet valve and drainage system may be damaged. You must first move it to a room temperature environment and let it stand for 24 hours before using it.

Please confirm that the power socket is reliably grounded, and the grounding terminal should not be connected to public facilities such as gas pipes, water pipes, and heating pipes.



# Component

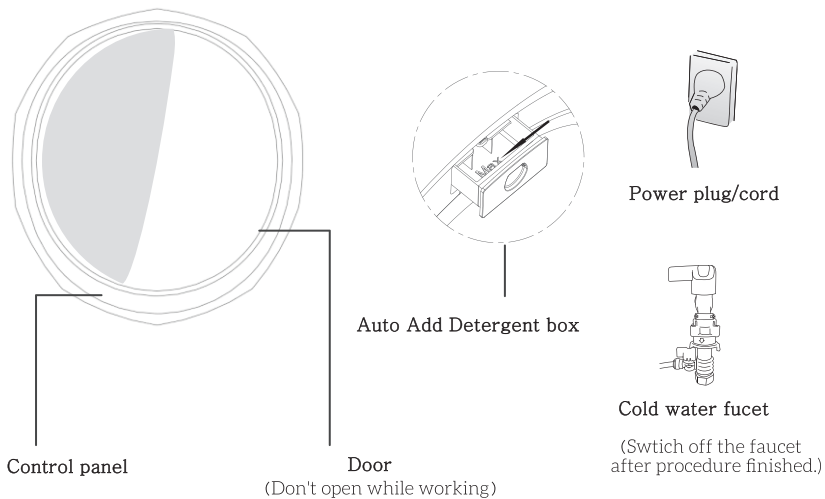

## Parts

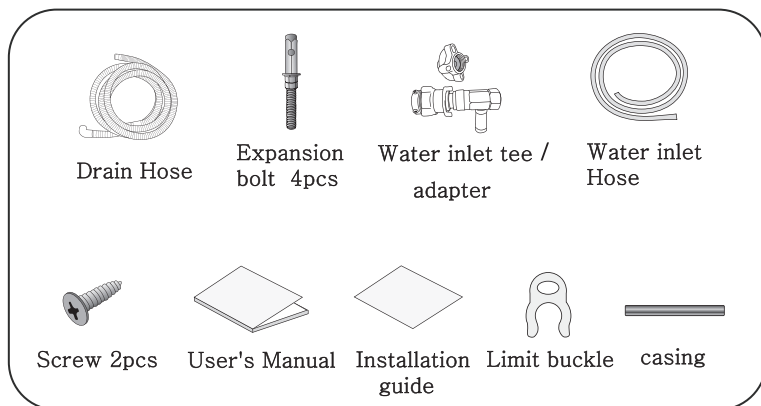

Buy the extension inlet hose or drain hose from your service center. Use the new hose assembly that comes with the appliance, and the old hose assembly cannot be reused.

# Clothes can be washed



## Clothes can be washed

- underware and socks
- Skirt and T shirt
- Towels, handkerchiefs, pillowcases, kitchen towels and clean cloths
- baby clothes, diapers and underwear
- High-quality clothing, such as shirts, knitted clothing
- women clothing, such as underwear and socks

# Clothes can not be washed



## Clothes can not be washed

Products containing cotton or foamed polyurethane (sponge)

- All-wool blankets, electric blankets, blankets with a hair length of more than 10 mm, carpets
- Animal hair mats and oor mats
- Leather
- Down clothing
- curtain
- Too heavy jeans, bathrobes, bathroom mats, thick sportswear, etc.

## About the shrinking clothes

Due to different washing cycles, fabric types, weaving and sewing methods, and nishing methods, the degree of shrinkage of clothing is also different. Please read the laundry guide carefully before washing.

- Easy shrink Clothes Cotton shirts, synthetic ber socks, etc.
- No Easy shrink Clothes Polyester shirts, synthetic ber shirts and shirts, etc.

# About Detergent Box info

## Auto Add Detergent (optional models)

This machine has the function of automatic detergent addition, which can inject a large amount of liquid detergent at one time for multiple washings. The washing machine can automatically set the dosage of detergent according to the clothes. The user can also touch the "washing liquid" function key to select The dosage, the larger the number, the more the dosage. (It is recommended that users use the default settings)

**(1) Open the door, pull the tab on the upper part of the front panel, and pull out the detergent drawer.**

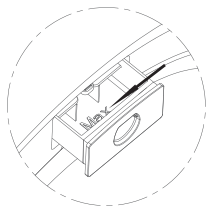

**(2) Slowly inject liquid detergent. Note that the maximum injection volume must not exceed the "MAX" mark. (Note: max 400ml in first time)**

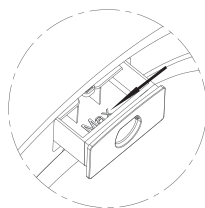

**(3) Push the detergent drawer and close it.**

## Add detergent manually

Each time the program is set before washing, press the "detergent" function key to "0", after canceling the automatic addition function, the user can directly put detergent into the tub as needed. (Reminder: No recommended manual add)

## Use Auto add Detergent Fuction

All washing programs of this machine are set with the automatic adding function by default.

The washing machine automatically sets the dosage according to the clothes. The user can also press the "Detergent" key to cancel or change the automatic adding function. (The default setting of the washing machine is the optimal design of the program. The user does not need to operate the "Detergent" key to select it. It is recommended that the user use it as much as possible to reduce unnecessary waste and affect the washing effect)

- 1.For the first time to use the automatic adding function, the detergent needs to fill the internal pipeline. You can choose "3" to increase the amount of detergent.
- 2.When filling liquid detergent in the drawer, do not exceed the maximum adding scale "MAX" line
- 3.Too viscous detergent is recommended to be diluted with water before filling
- 4.Please use low-foaming liquid detergent suitable for drum washing machine
- 5.Insufficient detergent level reminder: Before the washing machine is running, the "Detergent" icon on the function key flashes quickly, indicating that the detergent level is insufficient and needs to be replenished. (Note: After pressing the "Start" key to run, it will no longer remind)



**For models that do not automatically add detergent, the detergent is poured directly into the drum.**

**Please put in an appropriate amount of detergent according to the amount of washing, the degree of soiling of the clothes and the instructions of the detergent you choose.**

**Please use the special detergent for the drum washing machine. Do not use high-foaming washing powder, so as not to affect the washing effect or overflow the foam.**

# Wash Procedure

---

This machine adopts touch display control, and has heating function, please choose the appropriate washing method according to your needs.

## Open the door and put in the clothes

In order to ensure the best washing balance and avoid clothing wear, please distribute the clothing evenly in the drum.

## Close the door

When closing the door, pay attention to putting the sleeves, streamers, etc. completely into the inner bucket to avoid water leakage or damage to the clothes caused by the clothes being caught by the door and window pads.

## Power On

Touch the [Power] key to turn on the power.

After the power is turned on, the keys on the screen are all on. After 3 seconds, the washing machine enters the standby state. At this time, you can touch the keys to operate. If there is no operation within about 3 minutes, or the washing machine is not started within about 3 minutes after the program is selected, the washing machine will automatically turn off the power.

When the washing machine is running, if an error message appears or needs to be turned off, touch the [Power] key for about 3 seconds to turn off the washing machine.



# Procedure Select

USED FOR DY-BGX50W

Touch the key to select the desired program



## Smart

Suitable for cotton, linen, chemical ber ETC.

## Hot

For Kids Clothes

## Quick

For not dirty cotton

## Acacid

Special washing procedures for removing mites from clothing

## Baby

For kids clothes

## Shirt

For shirt

## Self-C

For Drum clean with hot water. Do not load clothes or detergent.

## Spin

For clothes spin after hand wash.

## R+Spin

For clothes rinse and spin after hand wash.

## Eco 40-60

For energy efficiency testing program

## Intense

For dirty clothes

## Care

Washing procedure suitable for underwear



The smart program will be intelligently adjusted based on information such as the material and weight of the laundry, and the program time may change.

When the water pressure is too low, the eccentricity is too large, etc., the program time may also change.

It is recommended that users run the drum cleaning program at least once every 3 months to clean the washing machine.





# Procedure Select

USED FOR DY-BGX50HW

Touch the key to select the desired program



<b>Smart</b> Suitable for cotton, linen, chemical ber ETC.	<b>Hot</b> For Kids Clothes	<b>Quick</b> For not dirty cotton	<b>Acarid</b> Special washing procedures for removing mites from clothing
<b>Baby</b> For kids clothes	<b>Self-C</b> For Drum clean with hot water. Do not load clothes or detergent.	<b>Spin</b> For clothes spin after hand wash.	<b>R+Spin</b> For clothes rinse and spin after hand wash.
<b>Eco 40-60</b> For energy efficiency testing program	<b>Intense</b> For dirty clothes	<b>Care</b> Washing procedure suitable for underwear	

## Dryer

For drying daily clothes (towels, socks and shirts) and other regular items (recommended to put only cotton and linen clothes). After touch Dryer program, select the appropriate drying time according to the texture and amount of clothes. The default time is 120 min, touch "Dry +" to select the drying time. The optional ranges are 30 min, 60 min, 90 min, 120 min, and 180 min. The longer the drying time, the better the drying effect.

### ATTENTION

1. Clothes weight less than 1.5kg.
2. Keep the cold water faucet on. (Improve the drying effect, there will be a small amount of water in and drainage)
3. After drying, the temperature of the drum drops to a certain level before the door can be opened.
4. Please note that when you take out the clothes, the clothes are still at a high temperature to avoid burns.
5. The clothes may shrink and deform slightly after drying, so confirm whether the clothes have been dried.
6. In order to prevent clothing damage and deformation, the setting drying degree is low, and the drying degree is not good. Press the drying program again.
7. In the drying operation, press "Dryer" 3's, the clothes in cooling, and the door can be opened after the cooling is over. (the cooling process more than 10mins)

## Wash+Dryer

Choose the Wash+drying program to wash and dry daily clothes (towels, socks and shirts) and other regular items. After selecting the washing program, press Dry+ to select the drying time. The washing machine will automatically enter the drying program after completing the selected washing program. For drying precautions, refer to the "single drying" procedure.



The smart program will be intelligently adjusted based on information such as the material and weight of the laundry, and the program time may change.

When the water pressure is too low, the eccentricity is too large, etc., the program time may also change.

It is recommended that users run the drum cleaning program at least once every 3 months to clean the washing machine.



## Set the program according to user's needs

USED FOR DY-BGX50W

Touch [Night], [Rinse+], [Detergent], [Temperature], [Water-Level], [Delay], to set different program.



### Night

Night washing is a low-noise program designed for the quiet time at night so as not to affect the rest of the people.

### Rinse+

Different rinsing times can be set in the smart washing, quick washing, children's clothing, underwear, gentle, rinsing+off programs. When choosing different rinsing times, the corresponding washing time will change.

### D-gent

By default, the washing detergent indicator of this machine is bright, and the user can touch this button to set the dosage or cancel this function. (Some models have this function)

### Temp

Different temperatures can be set in the smart washing, quick washing, kids clothing, underwear, Soft, Rinse + Spin programs.

### W-Level

Different water levels can be set in the smart washing, Hot washing, quick washing, Kids, underwear, Soft, Drum Clean, rinse+spin programs.

### Delay

It's valid only in the standby state. To select the delay time, you should first select the washing program and various function parameters, and then select it.



## Set the program according to user's needs

USED FOR DY-BGX50HW

Touch [Dry+], [Rinse+], [Detergent], [Temperature], [Delay], [OWD] to set different program.



### Dry+

After selecting the washing program press Dry+ to select the drying time. The washing machine will automatically enter the drying.

### Rinse+

Different rinsing times can be set in the smart washing, quick washing, children's clothing, underwear, gentle, rinsing+off programs. When choosing different rinsing times, the corresponding washing time will change.

### D-gent

By default, the washing detergent indicator of this machine is bright, and the user can touch this button to set the dosage or cancel this function. (Some models have this function)

### Temp

Different temperatures can be set in the smart washing, quick washing, kids clothing, underwear, Soft, Rinse + Spin programs.

### OWD

One button wash +dry for 55' fast washing + drying program.

### Delay

It's valid only in the standby state. To select the delay time, you should first select the washing program and various function parameters, and then select it.



# Function Select

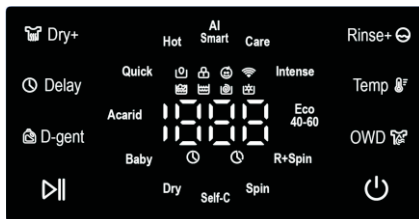

## Child lock function

In order to protect children's safety and prevent children from changing the washing process, this function is specially set up.

## Setting method

Before the washing program starts, touch the "temperature" button for 3 seconds, the "i" icon is always on, the child lock function is turned on, and the buttons are still selectable; after the program is started, the buttons (except the power button) are not selectable.

## Remedy

Before the washing program starts or during the washing process, when the [child lock] function is turned on, touch the "temperature" button for 3 seconds, the buzzer will beep once, the "i" icon light will go out, and the child lock function will be released. After the washing program is over, the [child lock] function is automatically cancelled.

## Add clothes midway

In the running state, press the "Start/Pause" button to detect the water level, temperature, and motor test, and automatically open the door when it meets the conditions for opening the door. When the door lock can be opened, clothes can be added. Press the "Start/Pause" button again to continue washing.

## Drum Light (Some models have this function)

In the standby state, the drum light is on when the door is unlocked; when the door is locked, the downlight is turned off after a delay of 30 seconds.

In the working state, touch any function key, the drum light will light up and light off after a delay of 30 seconds.

At the end of the program, the door lock is unlocked, the drum light will automatically turn on for about 5 minutes and then off automatically, during which the drum light will go out when the user shuts down.



# Run and Finish

## Run

Touch the [Start/Pause] key and hear a "pop" when the door lock locks the door, and the washing machine starts to run. After running, please do not pull or pry the door hard to avoid danger.

### Door lock release method:

To ensure safety, when the washing machine is running, the door is locked and the door lock icon will appear on the display

If you need to unlock during the washing process, please touch the start/pause button on the screen rst, and the door can be opened after the door lock icon disappears. In some cases, such as the water level in the drum is too high, the temperature is too high, the inner drum is rotating, etc., even if the program is suspended, the door lock will not be opened immediately for user safety. This is a normal; wait until the water level drops and the temperature drops , The door can be opened only after the inner drum has completely stopped rotating.

If you need to open the door lock in the child lock state, please remove the child lock rst, and then touch the start/pause button to pause the operation of the washing machine to unlock the door.

### Lovely reminder

Under different water pressures, different fabrics, and different amounts of cloth, the display time and actual running time of the washing machine may be different.

## Finish

### Power off

### Take out the clothes

After washing, please take out the laundry in time. If it is left for a long time, the clothes are prone to wrinkles, bacteria and odors.

### Open the wash door

To keep the inner tub of the washing machine clean, please open the door for a period of time, and then close the door after it has dried.

### Turn off the faucet

To prevent water leakage, please turn off the faucet after washing. Unplug the power cord To prevent electric shock, do not plug in and out the power cord with wet hands.



# Daily care and maintenance

Follow the cleaning instructions below to ensure the long-term sanitary use of the washing machine.

- Unplug the power cord before cleaning the washing machine. Otherwise, it may cause electric shock or personal injury.
- Do not spill water on the washing machine. Otherwise, it may cause a short circuit or electric shock.

## Washing Machine Clean

Use a clean damp cloth to clean the washing machine. Do not rinse the cabinet directly with water.

Do not use synthetic detergents or detergents containing benzene, otherwise the plastic part of the washing machine may be damaged.

Do not use thinner, gasoline, alcohol and other volatile materials to wipe.

## Drum Clean

### Rust

If you put embroidered water or rusty items such as hairpins into the barrel, or if water stays in the barrel for too long, it may cause rust.

### Derusting

Squeeze the derusting paste onto a soft cloth or sponge, and then wipe the rusty part.

Do not use wire brushes, otherwise the rollers will be damaged.

### Detergent residue

(dark colors and stains) If you use the washing machine for a long time, add too much detergent, or repeat the cleaning process with detergent that is not completely dissolved, it may cause detergent residue to contaminate the clothes.



# Daily care and maintenance

## Emergency Drain

- Use a screwdriver to unscrew the emergency drain cap fastening screw.
- Unplug the emergency drain pipe from the emergency drain plug, align the nozzle of the pipe to the container prepared in advance, and let the water drain into the container.
- After the water is drained, reinsert the emergency drain plug into the emergency drain plug, and pay attention to the end of the pipe. Use a Phillips screwdriver to re-tighten the emergency drain plug.
- Note: Please do not use this function for non-special emergencies



## Emergency door opening (some models have this function)

- Use a screwdriver to loosen the fastening screws of the emergency door opening cover.
  - Hold the emergency door opener and pull the wire rope down slightly. After hearing a slight noise, you can open the door and take out the clothes.
  - The wire rope recovers after letting go.
- Use a Phillips screwdriver to refasten the emergency door opening cover. Note:
- Please do not use this function for non-special emergencies



# Installation

## Before installation

Do not plug while installing the washing machine.

## After installation

Check if there are any water leaks or abnormal noise, by running the program.

### 1. Determine the installation location



Install after discussing the installation location with the customer.

The position is high to the chest for easy installation.

It is easy to install and use near the water supply, drain and socket.

### 2. Check the wall

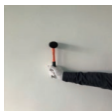

Use a leather hammer to hit the wall. If the echo is dull, it may be a hollow wall, and if the echo is crisp, it is a solid wall. The installation location must be a solid concrete wall. Install the washing machine on the wall.

### 3. Paste the installation Guide guide



Paste using a spirit level. Paste the installation guide and mark the hole points.

The installation guide is attached according to the actual size of the product.

### 4-1. Drill a hole through the tile



If there are tiles on the installation location, use a special drill to make holes on the tiles. Drill a hole perpendicular to the wall.

Do not drill holes on the edge of the wall tiles.

Do not drill holes under the faucet.

### 4-2. Drill holes in load-bearing wall

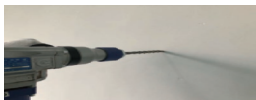

Make the impact drill perpendicular to the wall, and then drill holes into the load-bearing wall.

Follow the instructions on the hole diameter and depth specifications. Remove the dust in the hole.

### 5. Insert expansion bolts (4 cps)



Insert the expansion bolt and expansion sleeve into the hole.

The expansion bolt assembly is included in the product package. Insert the expansion bolt into the bottom of the wall hole.

The bolts of the expansion bolts must be at least 65mm higher than the wall.

### 6. Fixed expansion bolt



Knock the sleeve to expand the expansion sleeve on the expansion bolt.

If the expansion sleeve protrudes from the wall after fixing, it needs to be fixed again.

### 7-1. Separate the fuselage



You need to remove the 4 screws from the top and bottom of the fuselage shell to separate the fuselage shell and the body.

### 7-2. Connect the inlet water



Insert the water inlet pipe into the water inlet valve interface or the water inlet tee, insert a depth of 15mm or more (with a black line), and install the locking card.



## 7-3.Connect the Drain Pipe

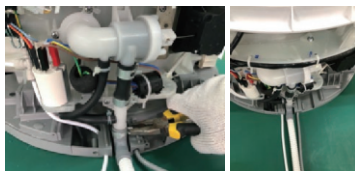

Fix the drain pipe on the drain tee and clamp the card. Place the water inlet pipe and the drain hose in the wiring hole. Connect the hose correctly to prevent water leakage. After the connection is completed, insert the water/drain hose into the wiring hole.

## 8.Install and fix washing machine

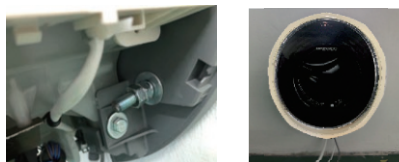

Install the washing machine on the wall surface. Fix 1 flat washer, 1 spring washer, and 2 nuts on the bolts. Tighten the fixing nut, and then tighten another. Overtightening the nut may damage the product or wall tiles. The lock nut needs to be tightened.

## 9-1.Install the inlet pipe for Two washing machines share a faucet connection

1. Unscrew the blocking cover from the lower part of the water inlet tee;

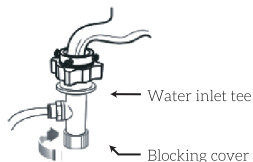

2. Connect the adapter to the water inlet tee and tighten it;

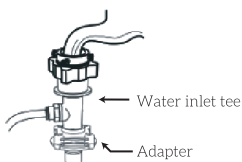

3. Press down the sliding sleeve to complete the connection between the water inlet pipe and the adapter;

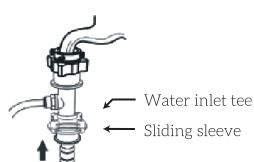

## 9-2.Install the inlet pipe for one washing machines a faucet connection

1. Connect the water inlet tee to the faucet, insert the water inlet pipe into the water inlet tee, the insertion depth is 15mm.

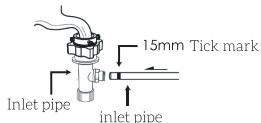

installation tips:

There should be no power sockets or other electrical equipment under the machine, and there should be no faucets, table tops and other obstacles that affect installation and maintenance operations at the bottom 30mm. Please check if there is any water leakage after installation.

2. Insert the locking piece onto the clamp ring.

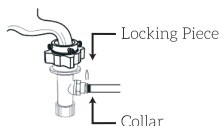

## 10.Runing Test



Carry out a running test to check for malfunctions or water leakage.

## 11.Install Machine body



After installing the machine body, connect and tighten 4 screws at the top and bottom. Check if there are any gaps on both sides.



# Installation

Recommended the professional maintenance engineer install the washing machine.

Hint

Wall type	Hole depth	Hammer drill bit diameter	Tile hole diameter
cement wall	65mm	Ø14mm	Ø15mm
Brick wall	The distance between the tiles and the retaining wall +65mm		—

## Installation diagram

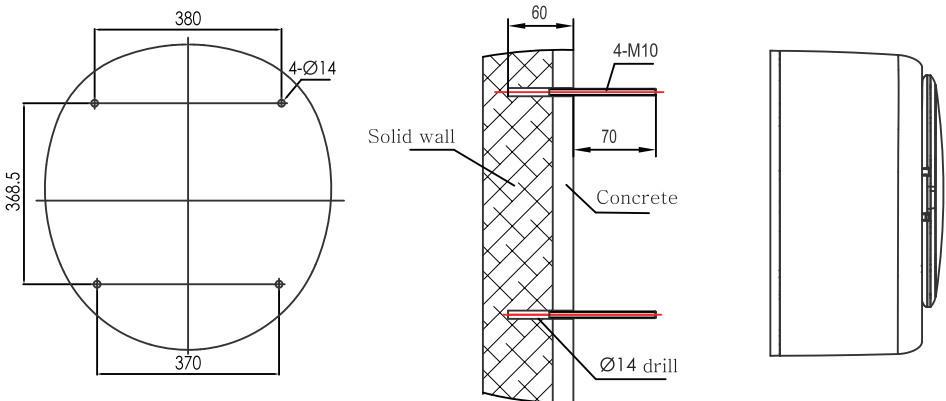

- ▶ Electrical grounding to prevent electric shock. Check the availability of the circuit breaker.  
-For more detailed information, please contact the seller or customer service center.
- ▶ If the power outlet does not have a ground terminal:  
-For the safe use of the washing machine, it must be grounded.  
-Grounding measures must be carried out by service center engineers or professional maintenance person.  
-Please contact the nearest service center for details.
- ▶ It is forbidden to ground in the following locations.  
-Natural gas pipelines (risk of explosion or re)  
-Telephone lines or lightning rods (explosion or re risk)  
-Water pipes (many water pipes are made of plastic)  
-that exhaust air must not be discharged into a flue which is used for exhausting fumes from appliances burning gas or other fuels.

Change power cord

If the power cord is damaged, please contact the after-sales service center because special tools are required.

Change installation location

Please contact the service center to reinstall.



# When a suspected failure occurs

Some problems are mistakenly regarded as machine failures, although they are not. If there is any suspected failure, rst check the solution to the corresponding problem in the following table. If it still cannot be solved, please contact the seller or service center for consultation.

Issue	Check and Solution
1、 The washing machine stops during the washing process	1、 Check Error info: E01, E02, E04, E05, E06, E07, E08, E09, E10, E12, do, df, dt, Call Service Center
2、 Cannot supply water normally after starting the washing machine	2、 Check whether the water supply valve is open.
3、 The washing machine drains during the laundry process	3、 Are you using too much detergent? If there is too much foam on the clothes, it will drain even during the washing process.
4、 Water supply to the washing machine during dehydration	4、 During the spin process, the washing machine restores the water supply to spray detergent residues.
5、 Washing cycle is too long	5、 Low water pressure will prolong the water supply and the entire washing cycle.
6、 The washing machine makes a strange noise during the spin process	6、 Check if the power cord is properly connected to the washing machine.
7、 Fluctuating while running in the remaining time	7、 When the clothes are unevenly distributed in the drum, the remaining time will be extended.
8、 The remaining running time remains unchanged	8、 The temperature in the drum is too high, wait for it to cool down to prevent burns.
9、 Only a small amount of water supply during wash and rinse (low water pressure)	9、 When the water level is low and the water surface is not easy to identify, but this is not caused by a machine failure, the front load washing machine consumes a small amount of water when soaking the clothes, and wash and rinse the clothes by rotating and falling in the clothes.
10、 After the spin starts, the drum does not spin or runs very slowly	10、 If too much detergent is added or the middle part of the drain pipe is bent upwards causing poor drainage, the spin speed will decrease. At this time, drain out the water and spin again.
11、 Cannot perform key operation	11、 Whether the child lock function is turned on.
12、 There may be a small amount of water in the drain pipe and the machine when the first use.	12、 normal. A small amount of water remaining during factory inspection.
13、 Stop in the middle of running	13、 Whether the power is suddenly cut off or the water is cut off; whether the start/pause button is pressed



# Before Contact the Service Center

Press the power off to stop the operation of the washing machine, and then check the following items, power on again to resume operation.

Issue/Display	Check and Solution
No Display: Washing Machine Not Work	Please check whether the power cord is correctly connected to the power socket; Check whether the start/pause key is on; whether the indoor circuit is powered off.
E01 : Water Inlet Abnormal	Please check if the water faucet is turned on, the water pressure is too low or the water is cut off.
E02 : Overflow Abnormal	Please turn off the faucet and contact maintenance person.
E04 : Drain Abnormal	Please check if the drain valve is blocked and the drain pipe is bent.
E05 : Door Lock Abnormal	Re-close the door of the washing machine, press the start pause button and re-lock the door.
E06 : Door Lock Unlock Abnormal	Open the door after pressing the start pause key
E07 : Water Sensor Abnormal	cut off the power and water, contact service person.
E10 : Communicate Error	cut off the power and water, contact service person.
do : The Temperature Sensor of the Drying Outlet Abnormal	cut off the power and water, contact service person.
df : Drying Fan Motor Abnormal	cut off the power and water, contact service person.
dt : Drying Heater Abnormal	cut off the power and water, contact service person.
Unb : Spin Unbalance Abnormal	Take out the clothes and shake them evenly. Spin again. If it still appears, add 2-3 pieces of towels and other small clothes to spin again.



# The name and content of hazardous substances in the product

According to China's "Marking Requirements for Restricted Use of Hazardous Substances in Electrical and Electronic Products".

Distinguish	Pb	Hg	Cd	Cr (VI)	PBB	PBDR
External parts (housing, panel)	O	O	O	O	O	O
Motor	O	O	O	O	O	O
Heating Pipe	O	O	O	O	O	O
Internal Parts (Drum, Hanger)	O	O	O	O	O	O
Electric Parts	X	O	O	O	O	O
Plastic parts	O	O	O	O	O	O
Water inlet/outlet Pipe	O	O	O	O	O	O
Label	O	O	O	O	O	O
PCB	X	O	O	O	O	O
Power Cord, Connect Wire	O	O	O	O	O	O
Connector	O	O	O	O	O	O
Screw Bolt	O	O	O	O	O	O

## This form is compiled in accordance with the provisions of SJ/T 11384

O=It means that the content of the hazardous substance in all homogeneous materials of the part is below the limit requirement specified in GB/T 26572.

X=It means that the content of the hazardous substance in at least one of the homogeneous materials of the part exceeds the limit requirement of GB/T 26572.



## Product specifications and wiring diagrams

Model	DY-BGX50W	DY-BGX50HW
Power	220~240v, 50/60Hz	
Rated Wash Capacity	2.5kg	2.5kg
Rated Spin Capacity	2.5kg	2.5kg
Rated Dry Capacity	/	1.5kg
Rated Input Power	1500W	
Machine Size (mm)	620*580*350	
Noise dB (A)	Wash<45dB, Spin<55dB	
Executive standard	EN 60335-1, EN 60335-2-7, EN 60335-2-11, EN 62233	
Working Pressure	0.03-0.85MPa	



